



® 4242 Baldwin Boulevard
 Corpus Christi, Texas
 USA 78405-3399
 Tel: 800-531-3111, 361-888-5591
 Fax: 800-531-3108, 361-888-6510
 www.hortondoors.com
 The Automatic Choice

TECH DATA

ACTIVATING & SAFETY DEVICES

Key Switches, Rotary Switches and Radio Control Transmitters & Receivers

E2.5
 Jan 08

C529 ON/OFF Key Switch -
 Maintained contact. Jamb mounted.
 Black face plate with white letters.
 1 3/4" x 4 1/2" (44mm x 114mm).

C530 ON/OFF Key Switch -
 Momentary contact. Jamb mounted.
 Black face plate with white letters.
 1 3/4" x 4 1/2" (44mm x 114mm).

C529-2 ON/OFF Key Switch -
 Maintained contact. Wall mounted.
 Black face plate with white letters.
 2 3/4" x 4 1/2" (70mm x 114mm).

C530-2 ON/OFF Key Switch -
 Momentary contact. Wall mounted.
 Black face plate with white letters.
 2 3/4" x 4 1/2" (70mm x 114mm).

C3725 4 + 2 Position Key Switch -
 Positions include: 2-way automatic, hold open, 1-way exit, full open and partial open. Jamb mounted. White face plate with black letters. 1 3/4" x 4 1/2" (44 x 114).

C3725-1 4 Position Key Switch -
 Positions include: 2-way automatic, hold open, off and 1-way exit. Jamb mounted. White face plate with black letters. 1 3/4" x 4 1/2" (44 x 114).

C3726 4 + 2 Position Rotary Switch -
 Positions include: 2-way automatic, hold open, 1-way exit, full open and partial open. Jamb mounted. White face plate with black letters. 1 3/4" x 4 1/2" (44 x 114).

C3726-1 4 Position Rotary Switch -
 Positions include: 2-way automatic, hold open, off and 1-way exit. Jamb mounted. White face plate with black letters. 1 3/4" x 4 1/2" (44 x 114).

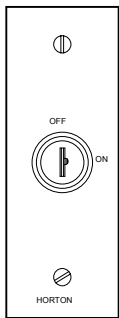

C529 / C530

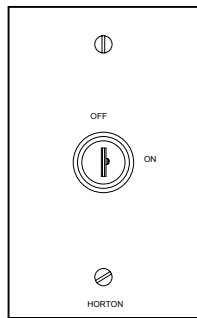

C529-2 / C530-2

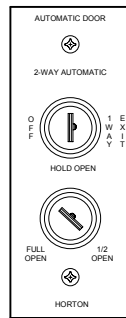

C3725

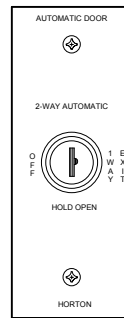

C3725-1

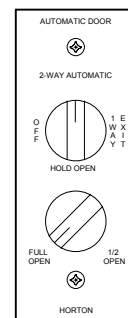

C3726

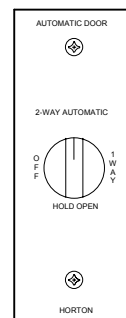

C3726-1

For use on all products

For use on slide doors

For use on slide doors

C1330-1 Double Radio Control Assembly -
 For use on handicap designated openings. Includes two transmitters 4" square x 1 3/8" deep (102 x 102 x 35) with blue molded acrylic cover, raised white lettering and a 1" (25) diameter red button. Also one header-mounted receiver.

C1340-1 Single Radio Control Assembly -
 Includes one hand-held transmitter 3/4" x 2 1/4" x 3 3/4" (19 x 57 x 95) and one header mounted receiver.

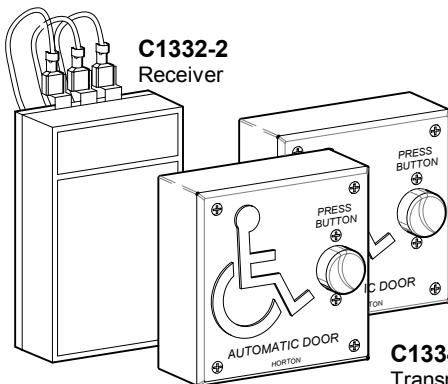

C1334-2
 Transmitters



C1342-1
 Transmitter

For use on slide swing and folding