



® 4242 Baldwin Boulevard  
 Corpus Christi, Texas  
 USA 78405-3399  
 Tel: 800-531-3111, 361-888-5591  
 Fax: 800-531-3108, 361-888-6510  
 www.hortondoors.com  
 The Automatic Choice

# SPECIFICATION DETAILS

## AUTOMATIC FOLDING DOORS

FoldingAccess®

Optional Push Bar, Pull Handle & Horizontal Rails

B15.0

Jan 08

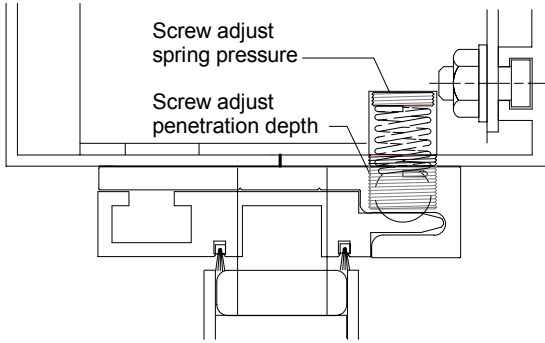

The force required to break-out a door, for emergency egress will be no more than 50 lbs. (222N) applied 1" from the edge of the lockstile (per ANSI 156.10).

**Standard Ball Catch at Header**

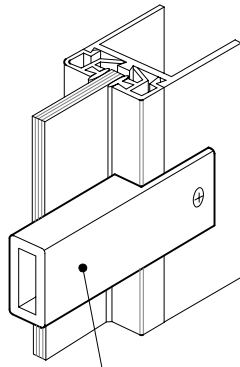
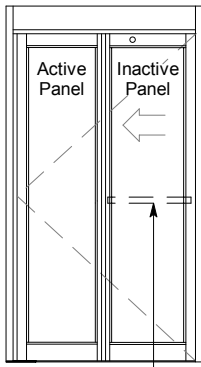
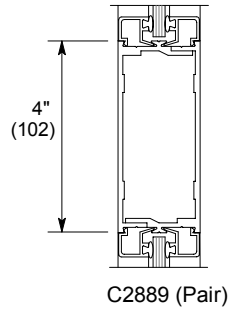
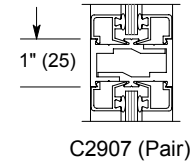
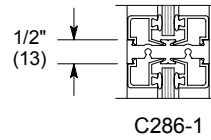

Sent loose & field mounted on interior side of breakout panels if no midrail is specified.

3/4" (19) x 1 1/2" (38)

**C287-1 Standard Pushbar**

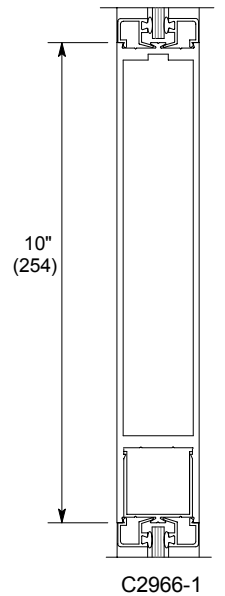
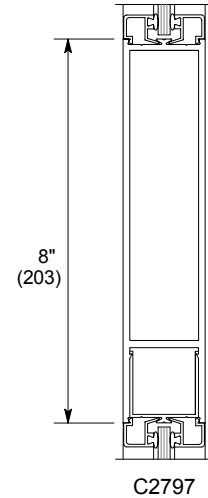
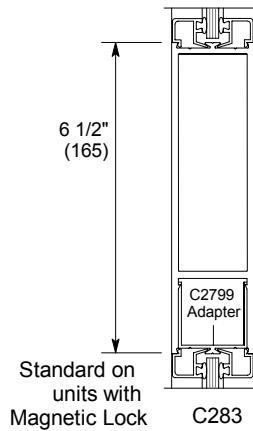

**Optional Muntins**

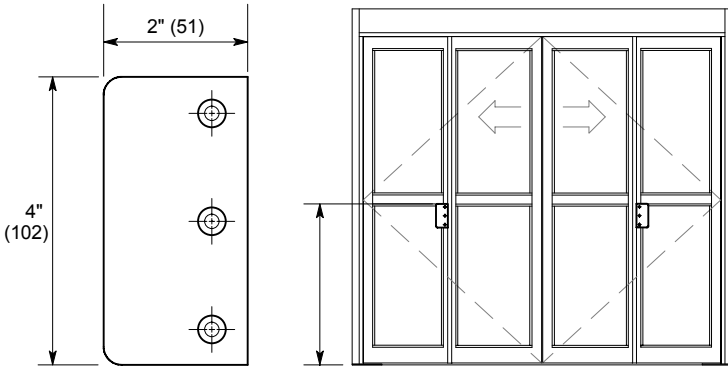
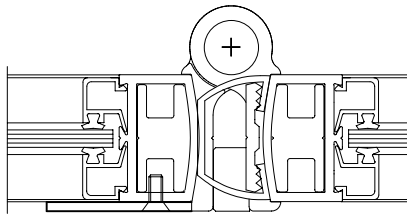

Top of handle 3'-5" or flush with bottom of standard muntin bar. Field mounted on side opposite hinge.

**C7641 Pull Handle**  
 For manual operation

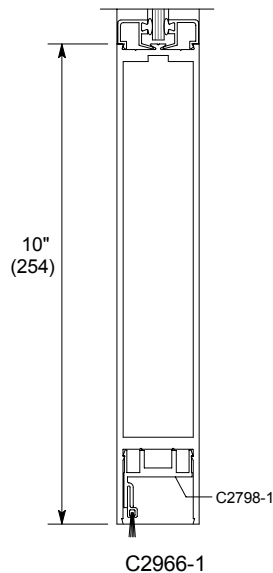
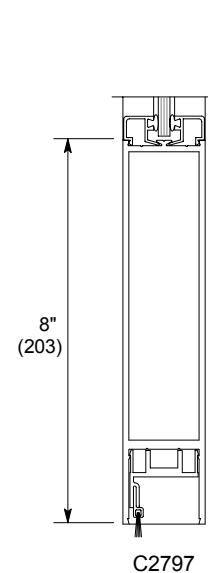
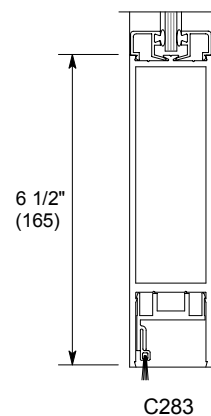

**Optional Bottom Rails**

All shown with standard 1/4" glazing prep.